

PUMPS FROM THE DUMP

Suresh Vaidyarajan & Arvind Gupta

Illustrations by: Avinash Deshpande

Published by Vigyan Prasar
C-24 Qutub Institutional Area,
New Delhi 110016 (India)

Price Indian Rupees Twenty only.

Send your comments to arvindguptatoys@hotmail.com

PUMPS FROM THE DUMP

Every little child does it
Making things from odds and bit
The whole world is a garbage pit
Collect some junk and make a kit.

You'll never be at a loss
Make do what you come across
Con - rod, piston, suction port
All these parts you don't import.

Little things all strewn around
A soda - cap lying on the ground
A hose, a spoke, a hollow stem
Lids and bottles all of them

Use these things to make a pump
A pump assembled from the dump
A pump to make the water pump
To quickly empty out the sump.

Making pumps will bring great joy
For each of them is a working toy
Play with them and get a feel
What's a valve and what's a seal.

It's best to try a theory out
Then you'll know it inside - out
Think, adapt and improvise
That's the rule of the wise.

Several pumps go up and down
While many pumps go round and round
Pumps are made of many parts
But the best pump is the heart.

Pumps bring water to the field
And thus better food crop yield
Pumps lift water from the well
Life without a pump is hell!

Various Valves

A valve is the heart of a pump. And there are many-many to make simple valves, using very ordinary materials.

What is a valve?

A valve is a device, which enables water, or air to flow in one direction only. It prevents the flow in the reverse direction. A valve is like a traffic policeman, on a 'one-way' road. He allows traffic to go in one direction only, and stops all traffic in the reverse direction. He always says GO to traffic in one direction and STOP it in the opposite direction.

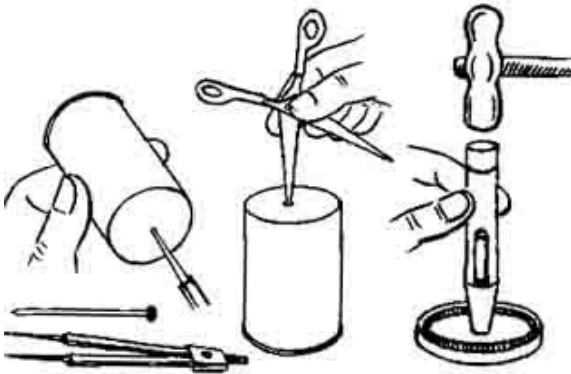

How to make a hole in a bottle or a lid?

Take a film reel bottle and poke a hole in its base with a divider point.

By rotating a taper scissors in this hole you can make the hole bigger.

A hole of 8-mm in diameter should be good enough.

You must ensure that the edges of the hole are clean - without any burrs or protrusions.

You can also make neat holes using a shoemaker's punch.



Balloon Valve

Cut a balloon about 2.5-cm from the mouth end.

Stretch the mouth of the cut balloon and slide it on the threaded end of a toothpaste tube.

If you blow in from the tube then the balloon will open and allow air to pass through. But if you suck from the tube end then the balloon will close and shut the passage of air.

This makes a very efficient valve.



Marble Valve

Make a hole of about 8-mm diameter in the center of the film reel bottle lid. Place a glass marble on it.

This valve will allow water to flow from bottom up, but will prevent passage of water from the top to the bottom.

The problem with using steel ball bearings is that they quickly rust in water.

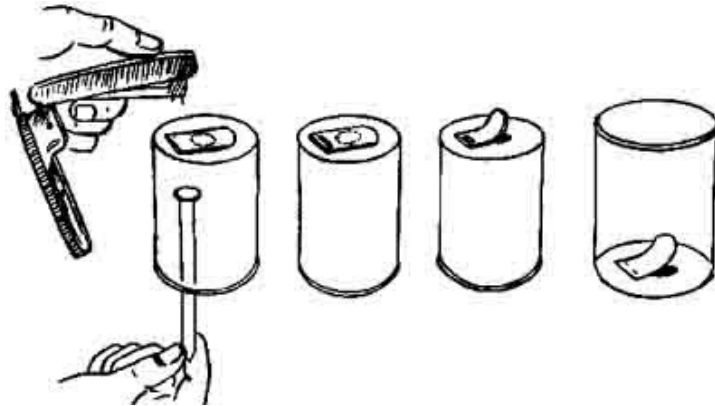

Flap Valves

Cut a 1 x 1.5-cm flat piece from an old bicycle rubber tube. This flap can be hinged to the outer base of the bottle by applying a rubber adhesive like *Fevibond* on half the flap and sticking it. However, the rubber adhesive tends to come out, especially if you use the pump in water. So it is better to affix the flap by putting a staple on one side. Later the two prongs of the staple can be bent using a long nail. In this way the flap valve is mechanically and permanently attached to the bottle. If you suck through the bottle, the flap will shut the hole and the valve will be closed. If however, you blow in, then the valve will open and allow passage of air. You could affix the flap valve either on the outer base of the bottle as shown, or else you can fix it inside the bottle base too. Where you fix the valve would depend upon its use.

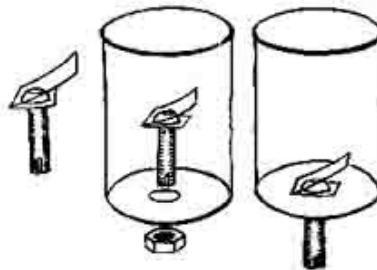

Plastic Strip Valve

One can also make a very efficient valve using the brass body of an old bicycle tube, and a strip of plastic sheet cut from an old milk bag. Make a hole in the strip and slip it inside the brass valve body. Then bend the strip on the circular seat of the brass body. Slip this valve in the base hole of a film reel bottle, and affix it with a lock nut. If you blow through the brass body, air will pass through. But if you try to suck through the valve body, the air will be stopped. This is a very efficient valve. Think of several other kinds of valves.

Inertia Pump

This is a simple and perhaps, a most amazing pump! Any hollow tube - PVC pipe, papaya stem, or a short length of bamboo, can be made to pump up water!

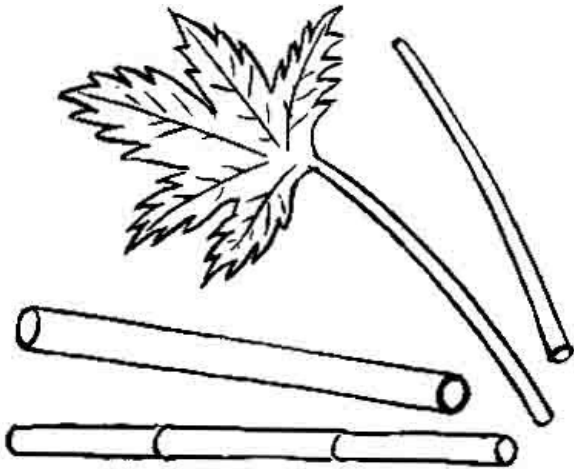

1. Can you convert a bamboo tube into a pump? Any hollow tube - a PVC or metal pipe, a short length of bamboo, or even a 30-cm long papaya stem can be made to pump up water.

Take a short length of bamboo.

Using a poker make a hole in the nodes, so that the bamboo becomes a connected hollow tube.

In villages, it is often easier to find a hollow plant item - like papaya stems. The nice thing about the papaya stem is that all children can have fun with their pumps and own them too.

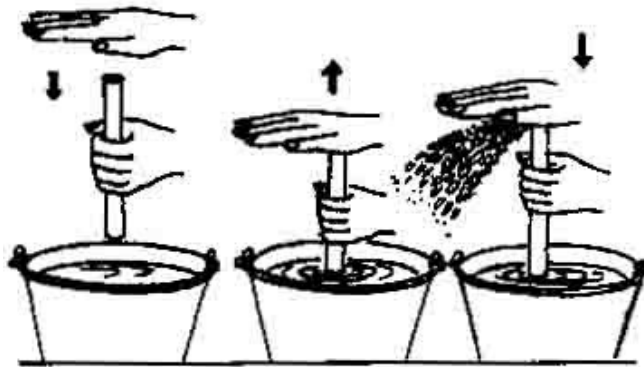

2. Take a 40 -50 cm PVC pipe, the kind, which is used, for household electrical wiring. Rub its ends on sandpaper to make them smooth. Hold the pipe with your left-hand and move it up and down into a bucket of water. Keep the palm of your right-hand or the top of the pipe and open and close it with each up and down reciprocation like a hinge. Soon water will start squirting out. In this case the up-down motion of the left-hand does the pumping while the right-palm acts like a valve. The use of the hand palm gives an excellent physical feel for a valve.

How does this pump work?

When the pipe is plunged in the water, because of the inertia of the water, a bit of the water rises in the pipe. Air is expelled as the palm is lifted and the top of the pipe is open. Now the palm closes the top. The water, which has risen, cannot go down. With every stroke, a little water rises in the pipe, and ultimately squirts out. Try and find the maximum height to which you lift water by this means? Modifications of this simple inertia pump are still used in parts of Andhra Pradesh (India) for lifting water.

Jerk Pump

This pump is akin to the Inertia Pump. There is a difference however. In this pump a foot valve replaces the hand palm valve.



1. Take a film roll plastic bottle and make a 8-mm hole in the center of its base. Cut a 1.5 x 1-cm piece of old cycle tube. Apply rubber adhesive (*Fevibond*) to one side of this rubber flap, and stick it inside the bottle (you can also staple it). The flap valve will open and close like a hinge.



2. Take a 30-cm long PVC pipe with an outer diameter of 2.5-cm. Cut a strip from an old bicycle tube 2 x 20-cm long.



3. Wrap the rubber strip tightly on one end of the pipe and secure it in place with a bit of rubber adhesive like *Fevibond*. This end of the pipe should be just thick enough to fit into the mouth of the film roll bottle.



4. Tightly fit the pipe in the bottle.

5. Attach a right angle bend to the top of the pipe.

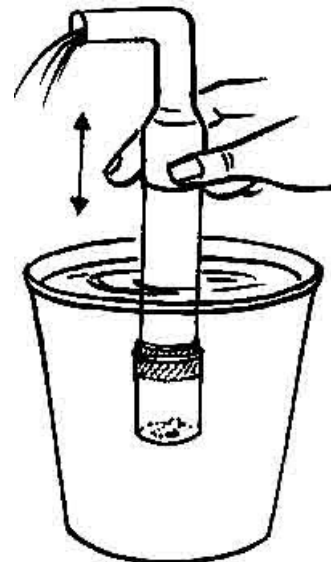

6. Now hold the pipe with one hand and move it up and down in a bucket of water. Soon water will out from the PVC bend on each down stroke.

Toothpaste Tube Pump

This pump is just like the Jerk Pump. The only difference is that the materials used, both for the pipe and the valve are very different.

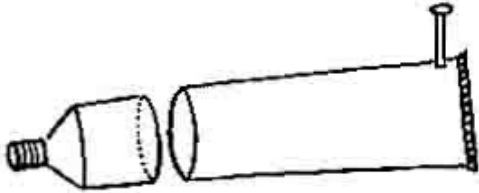

1. Old toothpaste tubes are not for throwing. Take a tube and cut it 2-cm from the mouth end. Clean it up. With a nail make a hole in the tube near the crimped base.

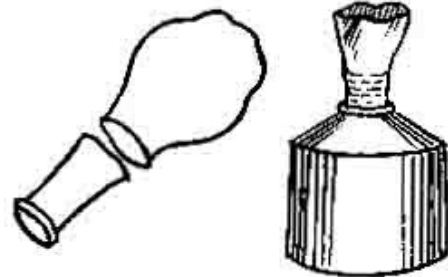

2. Cut a balloon about 2.5-cm from the mouth end. Stretch the mouth of the cut balloon and slide it on the threaded end of the mouth of the tube. This makes a very efficient valve.

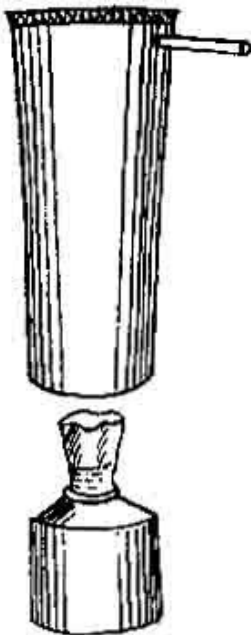

3. Insert this valve end in the big toothpaste tube as shown. Also insert a plastic straw (a *Frooti* straw or an old refill) in the hole near the crimped end. The cut balloon allows flow of water in one direction. Water can enter the tube from below but cannot come out from that end. The cut balloon is a very efficient valve.

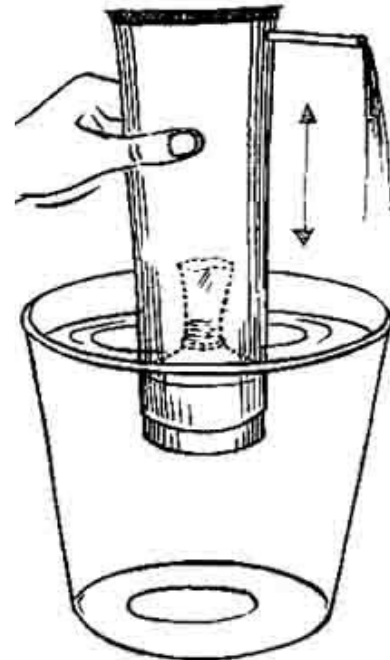

4. Hold the tube with your hand and move it up and down into a mug of water. After a couple of strokes water will start squirting out.

Tube Pump

Adding a piston and a delivery valve to the previous Jerk Pump can make the Tube Pump.

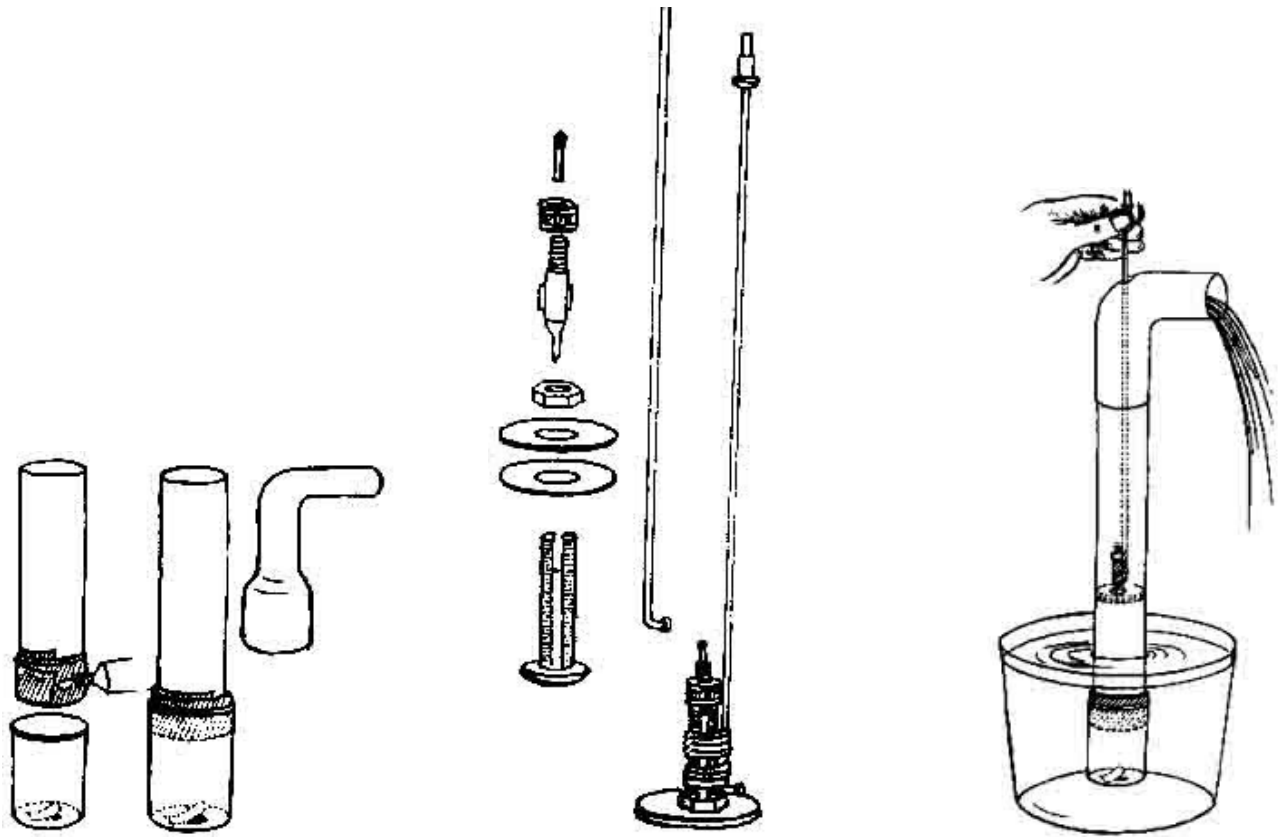

1. Take 20-cm long PVC pipe with an inner diameter of 2.5-cm. Cut a 2 x 20-cm long strip from an old bicycle tube. Wrap the rubber tightly on one end of the pipe and secure it in place with rubber glue, or tie it up with string. This end of the pipe should be just fat enough to fit into the mouth of a film reel bottle. Insert the pipe in a film reel bottle, which has a flap valve in its base.

2. For the piston cut two circular pieces of cycle tube rubber so that they move snugly inside the PVC pipe bore. Make holes in the center of these washers and after inserting them in the valve body, tighten them with a lock nut, insert a little matchstick in the valve stem and assemble it in the valve body with the brass cap. Tightly tie a cycle spoke to the valve body with thread. The spoke becomes the connecting rod. Make a small hole in the PVC pipe bend for the spoke.

3. Hold the pump in water and reciprocate the cycle spoke. On each upstroke the suction valve opens sucking the water in the tube. The delivery valve remains closed. On each down stroke the suction valve remains closed and the delivery valve opens allowing water to rise in the PVC pipe and gush out of the bend with a great force.

Hand Pump

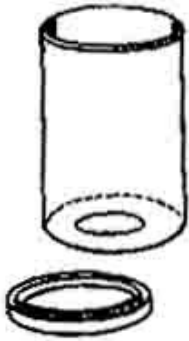

1. For making this pump you will require a black film-roll bottle, one more cap, a cycle spoke, old cycle tube, an old refill, simple hand tools and *Fevibond*- a rubber adhesive.

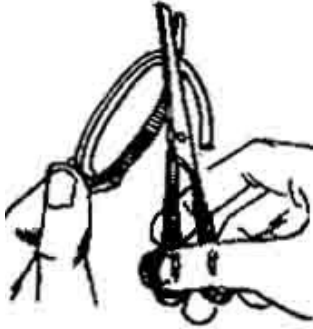

2. With a sharp scissors cut and remove the outer circle of the cap. The inner circle will make a superb piston. Rub it a little on sandpaper so that it is free inside the bottle – the cylinder.



3. Make a 2-mm hole in the center and a 6-mm hole for the delivery valve port. Apply rubber adhesive to a 2 x 1-cm piece of bicycle rubber tube and stick to the cover of the hole. This rubber will act like a hinge and open and close like a valve.



4. Cut a 12-cm long piece from a bicycle spoke. Fix the piston on the spoke thread with the help of two bicycle nipple-nuts.



5. This is the piston, delivery valve and connecting rod assembly.

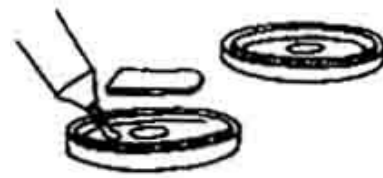

6. Take another film-roll bottle and make a 6-mm hole in it. Apply rubber adhesive to a 2 x 1-cm piece of tube rubber and stick it on one side to cover the hole. This is the suction valve.

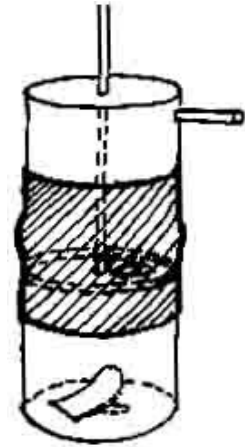
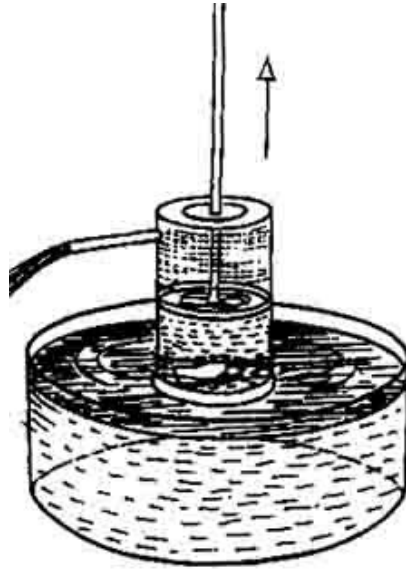
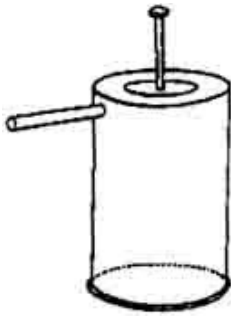

7. Make a 3-mm hole in the center of the bottle base so that the cycle spoke can move freely in it. Make another hole on the curved surface near the base and fix an old refill or *Frooti* straw in it. This is the delivery pipe.

8. Insert the spoke through the bottle base and snap the suction valve lid to complete the hand pump assembly. Keep the pump in a bowl of water and move the spoke up and down. After a few priming strokes large quanta of water will gush out. Both the rubber washers – stuck only on one side as hinges, act as very efficient valves. This is a superb model to understand the working of a real hand pump.

9. This model does not have a handle as there is in a regular hand pump. Can you think of a way of attaching a regular handle? The length of the bottle limits the stroke of the piston. You can put two film reel bottles with their mouths facing each other and slip a piece of old cycle tube to keep them together. By doing this you will double the length of the cylinder. Now much more water will come out of the pump with every stroke.

Sprinkler

1. Tie a meter long string to the top of a carrot. Slip the free end of the sting through empty ball pen body. Then tie it to a small potato.

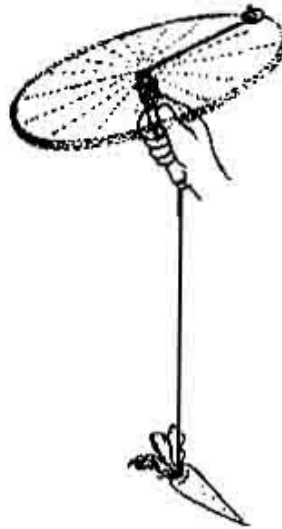
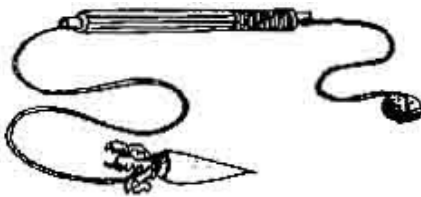

2. Hold the pen body in your hand and begin making circular motions - the potato must swing in a circle. As you increase the speed of rotation the carrot will rise. There is a force associated with the rotation of the potato. This force pulls away the center of the circle and is called **Centrifugal** force.

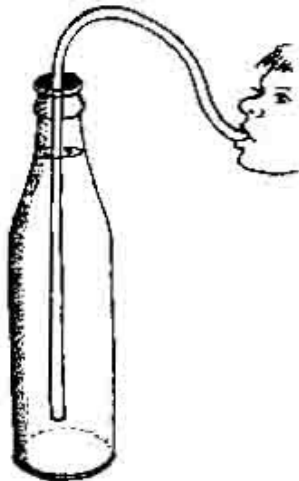

3. This simple sprinkler works on the same principle. Take a one-meter long flexible plastic tube - the one used as a petrol pipe or a mason's level tube. Keep one end of the tube immersed in a bottle of water and suck from the other end.

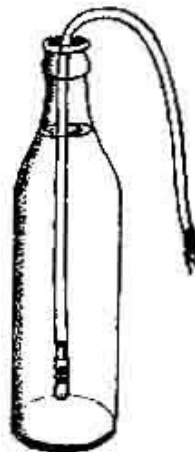

4. When water starts coming out from the other end of the tube start rotating it and slowly raise it.

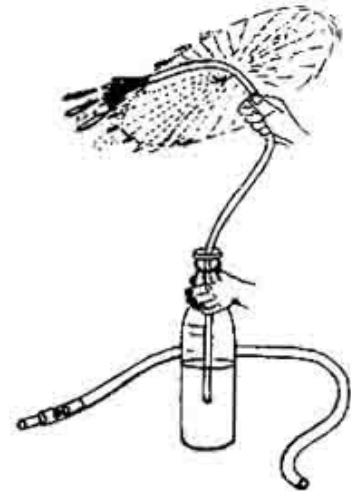

5. Water will keep sprinkling out as long as you continue spinning the tube. This way you can drain out the whole bottle. The centrifugal force of rotation is enough to suck and lift water from a height of almost a meter. You can make a simple foot valve using a cycle steel ball and a pen body as a seat.

Spray Pump

This is a very common household pump, used for spraying insecticides to kill mosquitoes and other pests.

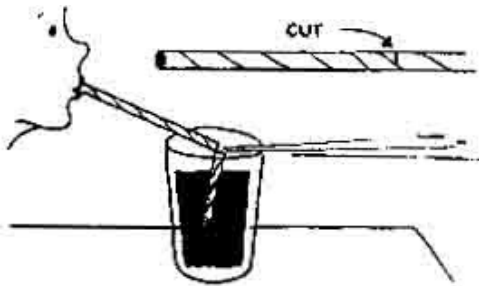

1. Make a slit in a plastic straw about one-third from one end. Bend the straw at the slit and place the short section in a glass of colored water. Make sure the slit is no more than 5-mm above the surface of the water. Blow hard through the straw. You will see that water enters the straw from the glass and comes out through the slit like a spray.

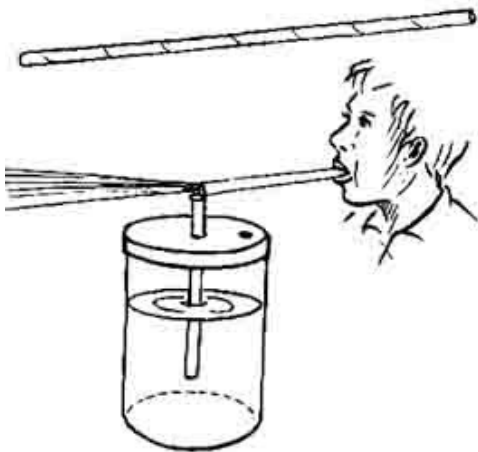

2. You can fix the same straw in a film reel bottle, by making a small hole in the center of the lid. Make one more hole near the rim of the lid for the air to enter. If you fill the bottle with a mixture of ink and water than you can catch the spray, once you blow, on an old newspaper. How does this pump work? When you blow hard, air comes out with great speed from the end of the straw. This high speed of air creates a low - pressure zone, at the cut. Because of the low pressure on the top of the vertical straw, water gets sucked up from the bottle, and gets blown as spray.



3. The familiar spray pump used in the house for spraying insecticides for killing and driving away mosquitoes is based on the same principle.

Bellows Pump

With this very efficient pump you can inflate a balloon with air or fill it with water.
This pump will also make a great *Pichkari* for *Holi*,
for with every down stroke of the pmp, 40-ml of water comes gushing out!



1. For making the pump you will need two film-reel bottles, 15-cm of old cycle tube, an old refill or a *Frooti* straw and some rubber based adhesive like *Fevibond* or *Vamicol*.

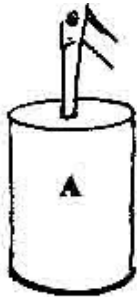

2. Make a hole in the base of the film-reel bottle **A** by using a divider point. Widen this hole by gentle rotating the pointed end of a scissors. The hole should be about 1-cm in diameter and should not have any burrs.



3. Make a similar hole in cap **B**.



4. Cut two circular washers about 1.5 an in diameter from a cycle rubber-tube. Apply *Fevibond* on half of the area of the two washers.



5. Apply *Fevibond* to the cap and paste one washer.



6. The washer stuck on one side act like a hinge. It can open and close like a valve. This is the **DELIVERY VALVE**.

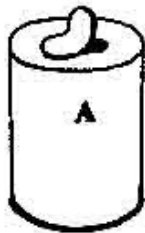

7. Paste the other valve on the base of the film-reel bottle. This is the **SUCTION VALVE**.

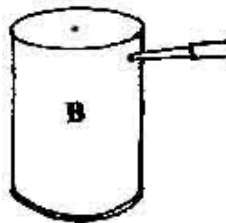

8. Take another film-reel bottle **B** and make a small hole on its cylindrical surface.

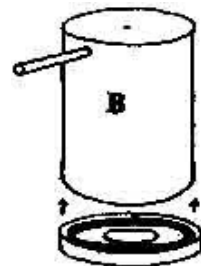

9. Press fit a short thick, stiff plastic straw for a delivery pipe. Fix the cap with the delivery valve to bottle **B**.

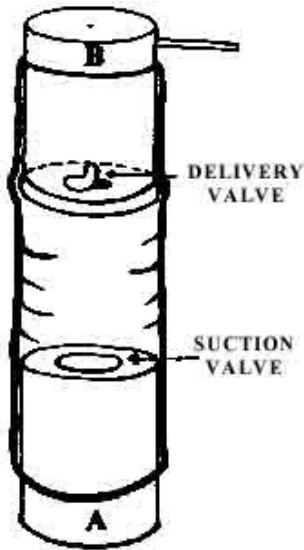

10. Cut a 15-cm long piece from an old cycle tube. Stretch and slide the tube over both the bottles as shown. The bottles will be separated by 7-cm of cycle tube. The rubber tube acts like a pair of bellows.

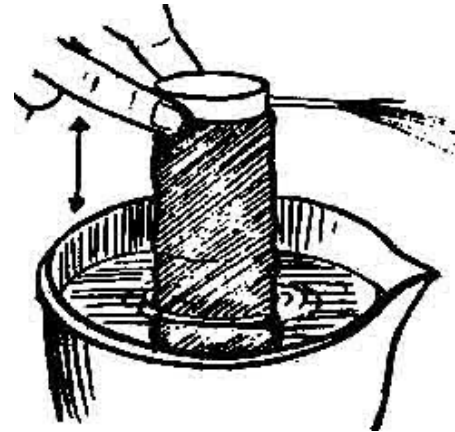

11. Now hold the lower bottle in water and press the top bottle B downwards. After a few initial strokes water will start gushing out of the delivery tube. Instead of pressing the top bottle up and down you can also squeeze it. Then the water will be squirted all around as in a sprinkler.

12. The Bellows Pump is based on a chance discovery that old bicycle tubes fit very snugly into film-roll bottles. Bicycle tubes come in several widths, so ensure that your bicycle tube fits on snugly or a bit tightly on the film bottles. Also ensure that the rubber tube flap valves sit flat at their seats. If the valve rubber is curved then there will be a crevice left and there will not be proper sealing. With this extremely efficient pump you **can inflate a balloon with air!** If you can fill a balloon with air then that is enough proof that indeed it is a great pump and that there is very little leakage from the valves

Film Bottle Rotary Pump

This pump is like the pump, which is used to draw out water from the well. The crown cap of this pump is pressed to a cycle tire, which rotates it fast and water gushes out.

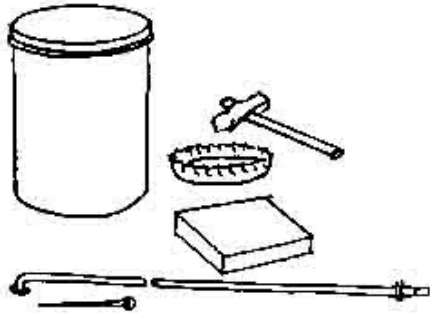

1. To make this pump you will need a film reel bottle, a bicycle spoke, a crown cap, a piece of rubber, a nail, an extra nipple nut, nail, hammer and some simple tools.

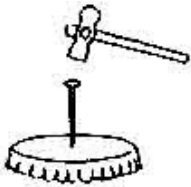

2. With the help of a nail, hammer a small hole in the center of the crown cap.

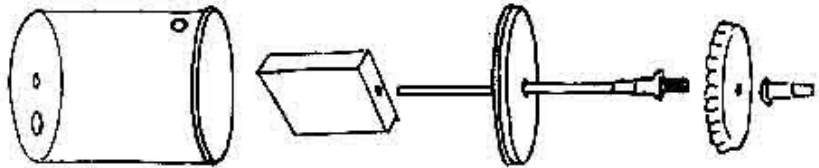

3. Make three holes in the film reel bottle and one in its cap as shown. Attach the rubber rotor to the spoke. The rubber rotor must move freely inside the bottle cylinder. Fix the soda water bottle, crown cap tightly between the nipple nuts of the spoke.

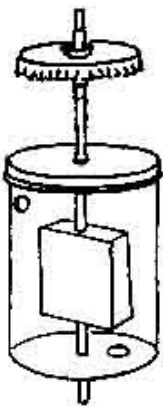

4. This is complete assembly of the film bottle rotary pump.



5. Keep the pump in an inclined position in a bowl of water, such that its inlet and outlet ports are diametrically opposite. Ask someone to put the cycle on the stand and crank the pedal. Press the crown cap of the pump to the rotating rubber tire. The rotor inside the pump will rotate very fast and water will gush forth with great force.

Wooden Rotary Pump



1. If a film bottle is not available for the outer casing of the rotary pump it can be easily improvised using three 5-cm square pieces of 1-cm thick wood.

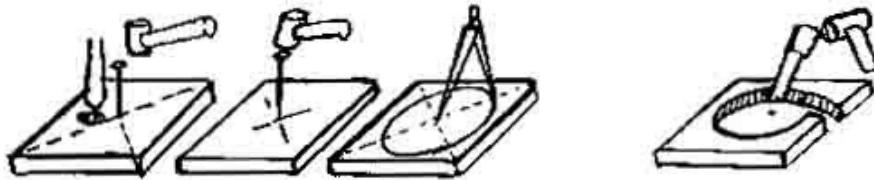

2. Make holes in the center of two pieces with a nail for the cycle spoke to pass through in one of these squares make a 5-mm hole about 1-cm away from the center for suction. In the third piece chisel out a circular 2.5-cm diameter bore and a channel for the outlet.



3. Make a hole in the center of a crown cap and fix it with two nipple nuts on a cycle spoke

4. Assemble the three pieces of the pump body with the rubber vane in the middle cavity. Keep the three-body pieces together by clipping two cycle tube rubber bands over them

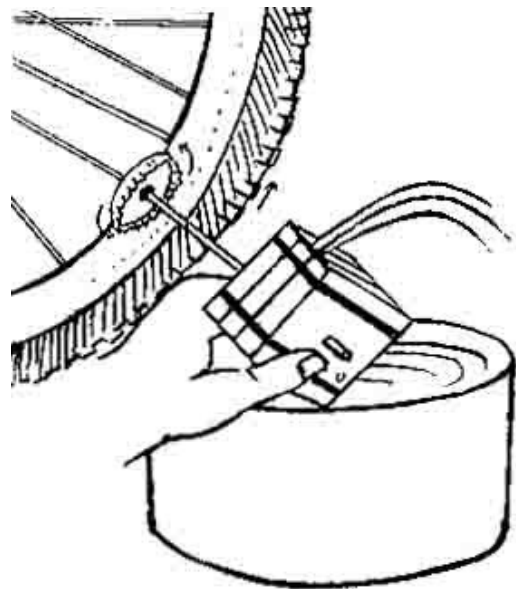
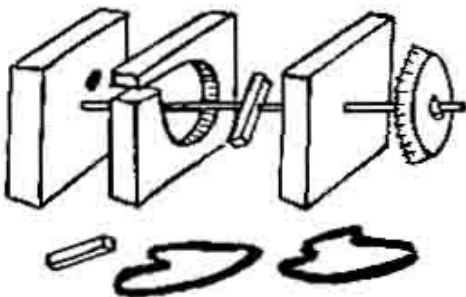

5. Dip the suction port in water and press the soda water cap against the rotating tire and enjoy the water gush out of the outlet.

Twin Tube Pump

In this pump the thin tube becomes the piston and the fat tube becomes the cylinder. There is a suction valve and a delivery valve. This pump throws 60-70 ml of water with every stroke.

Delivery Valve



1. Take an old cycle tube valve body. Insert the valve stem and then screw the brass cap lightly. Insert a small matchstick piece in the bore of the valve stem. Take a 2 x 15-cm long piece of old tube rubber and wrap it tightly around the brass valve body.

Piston

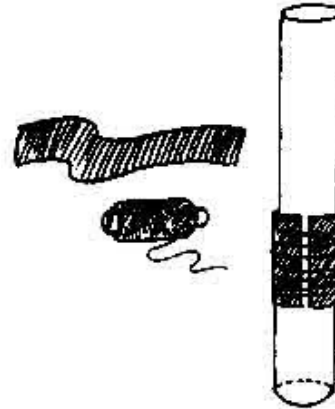

2 Take a 2-cm outer diameter and 30-cm long PVC pipe. Cut a 4 x 6-cm piece from an old cycle tube. Wrap just one layer of this tube on the PVC pipe and tie it with thread to secure it in place.

Piston and Delivery Valve Assembly

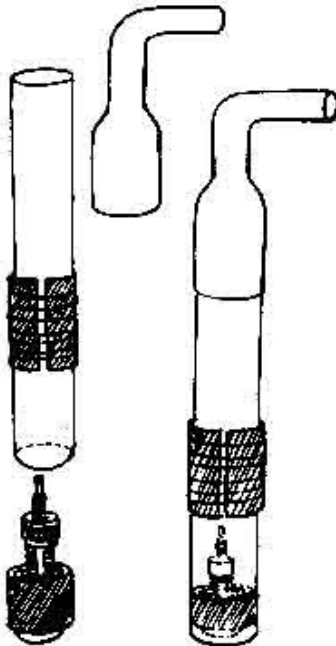

3. Insert the Delivery valve in the bore of the piston. The thickness of the wrapped rubber around the brass body should be such that it should be a tight fit in the bore. Also attach a bead to the top of the piston. It is through this bend that water will come out of the pump.

Cylinder and Suction Valve Assembly

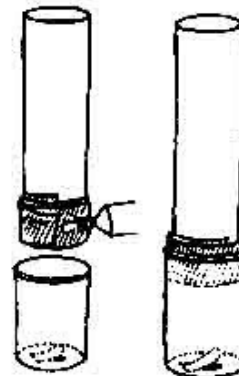

4. Take a 20-cm long PVC pipe with an outer diameter of 2.5-cm. Cut a 2 x 20-cm long strip from an old bicycle tube. Wrap the rubber tightly on one end of the pipe and secure it in place with rubber adhesive. This end of the pipe should be just fat enough to fit into the mouth of a film reel bottle. Insert the pipe in a film reel bottle, which has a flap valve in its base.

Piston and Cylinder Assembly

5. Before inserting the piston into the cylinder put a dab of oil. The oil will make the piston go smoothly up and down the cylinder. Now place the pump in water. Hold the cylinder with one hand and with the other move the piston up and down. Large quantities of water will gush out with great force

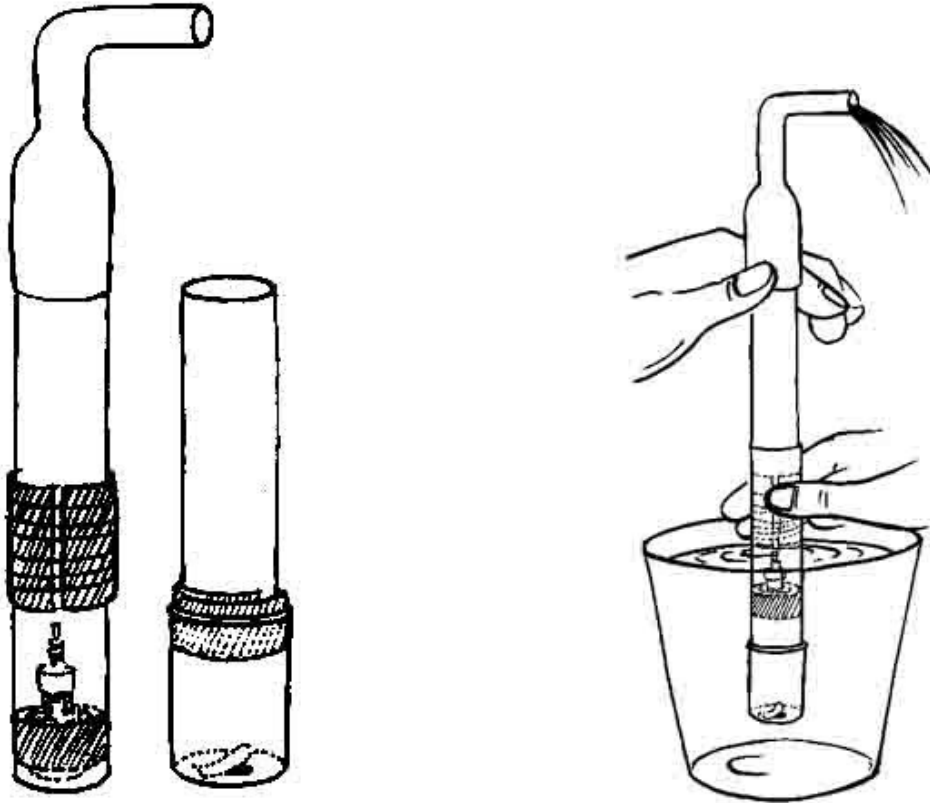

Screw Pump

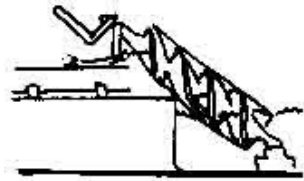
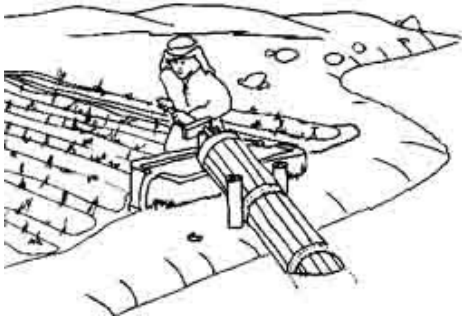

Here's a simple way of making a working model of the famous screw - designed some 2,300 years back. This screw pump was initially used to empty the ship holds of water, which had crept in through seepage. A man would just keep turning the screw and the water settled at the bottom of the ship would be thrown out. For thousands of years this pump has also been extensively used for irrigation - for raising water from the river Nile into the adjoining fields. The prosperity of civilizations of the Tigris and the Euphrates valley lay in the advent of the screw pump.

Such pumps are still being used in some parts of Orissa (India), to lift up water by about one meter from a pond into a nearby field.

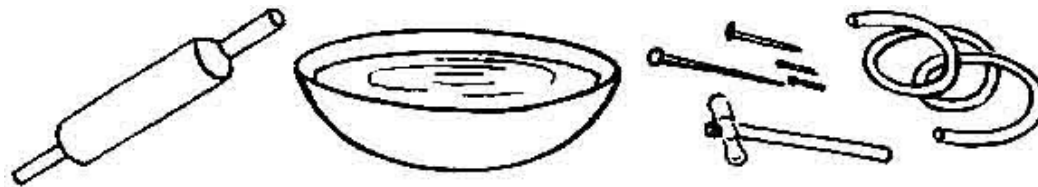

1. The materials required for making the screw pump are a wooden rolling pin - the traditional *belan*, 1.5-meters of flexible, transparent plastic hose with a outer diameter of about 1-cm. Apart from a bowl of water you will also require different sizes of nails and a hammer.

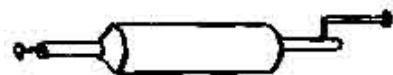

2. Fix two nails to the wooden rolling pin as shown. The left nail will become the pivot on which the pump will turn and the right bent nail will become the handle.



3. Wrap the plastic pipe over the wooden rolling pin.

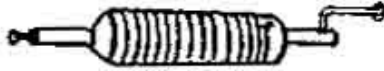

4. The two free ends of the plastic hose are secured to the wooden rolling pin by hammering shoe tack nails half way through, so that the plastic tube still retains its circular form and is not flattened out.

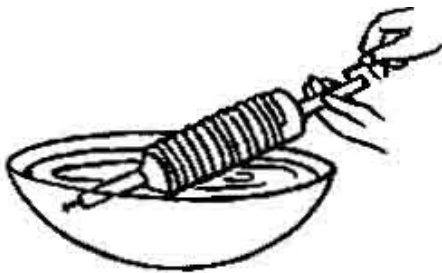

5. The pump is now ready for operation. Place it in an inclined position in a bowl full of water. The pump will turn about the left pivot nail - which will rest at the bottom of the bowl.

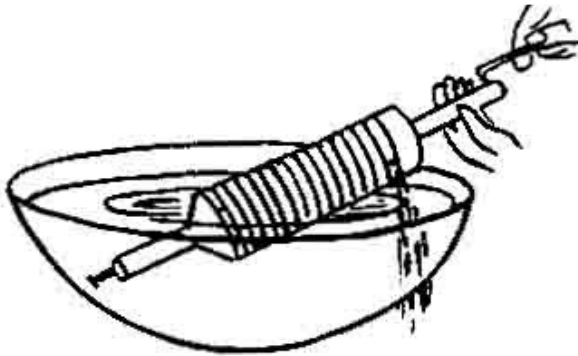

6. Support the right lower side of the wooden rolling pin with your left hand and turn the handle with your right hand. The lower end of the plastic tube will be immersed in the water. On rotating the rolling pin, water will rise up the spiral through of the plastic tube and squirt out of the other end.

Flywheel Pump

As you pull the thread water gushes out of the pump and the flywheel helps to rewind the thread on the spoke. This pump is simple to make and fun to play with.

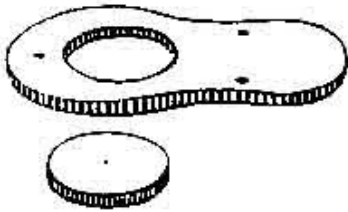

1. Cut a 7-cm diameter disc from an old rubber slipper. Make a small hole in its center. This is the flywheel, which will make the pump go round and round.

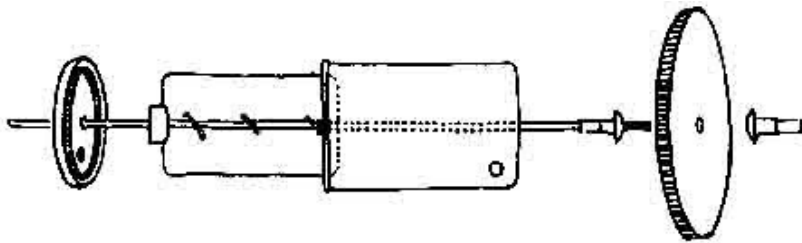

2. Cut a 14-cm long cycle spoke. Attach a 3-cm wide and 4-cm long piece of aluminum sheet rotor to the spoke at a distance of 5-cm from the left end. Make a series of holes on the rotor and tie it with thread to the spoke. Fix a little rubber washer next to the rotor. Put the rotor in a film reel bottle, with a hole for the water outlet. Attach the lid with two holes - one for the spoke and other for the water inlet. Fix the flywheel on the spoke with two nuts.

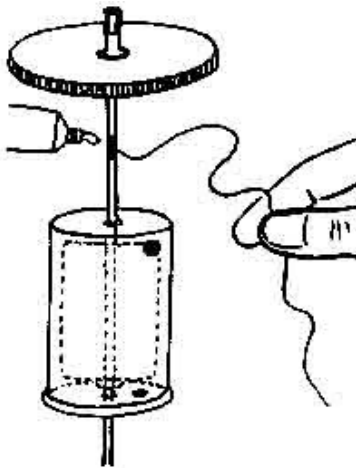

3. Tie 50-cm of thick but soft cotton thread to the spoke. Put a dab of rubber adhesive and tie a few knots so that the thread does not slip on the spoke. Now turn the flywheel a few times so that the thread loops around the spoke several times.

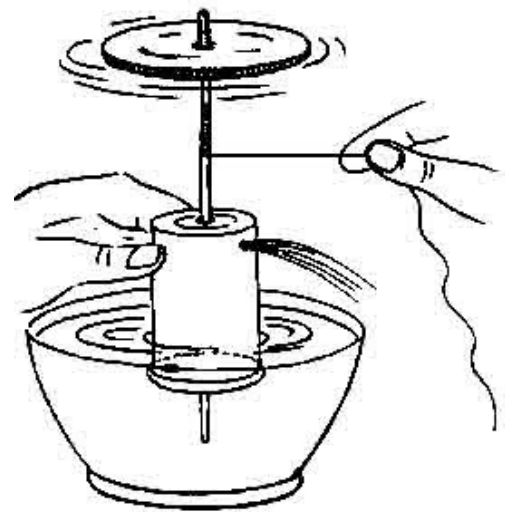

4. Keep the pump dipped in water in a vertical position and pull the thread. After a couple of pulls water will gush out of the pump and the flywheel will rewind the thread back on the spoke.

Squeeze Pump

This pump is based on alternate expansion and contraction of a rubber tube to squeeze out water.

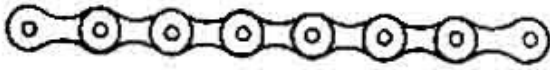

1. Five links of an old cycle chain are assembled as shown into a pentagon.

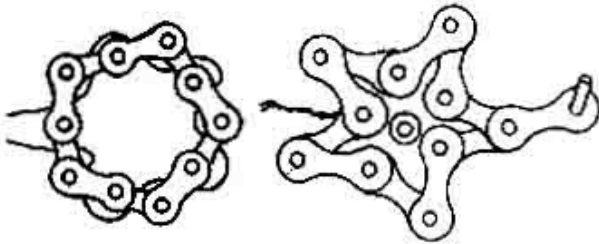

2. Weave a mild steel binding wire through the chain links and kink its two ends to make a five-pronged rotor. Rivet a link to any prong as a handle of the rotor

3. Mount the rotor with a screw on a plank of wood. Take a length of 5 - 6 mm internal diameter soft rubber tube - the red colored one, which is used, in laboratories. Fix one end of the rubber tube with a nail at the lower end of the plank. The rubber tube is then stretched over the rotor and its other end is nailed at a higher level. Place the lower end of the tube in a mug of water and turn the rotor. The alternate squeezing of the rubber tube creates a suction, which raises the water and squirts it out at the other end.

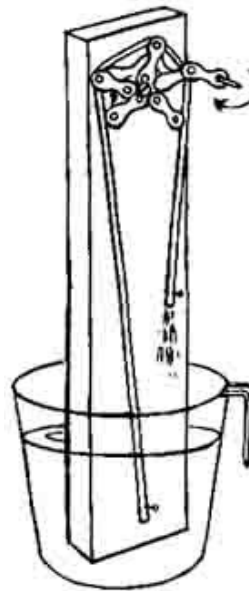
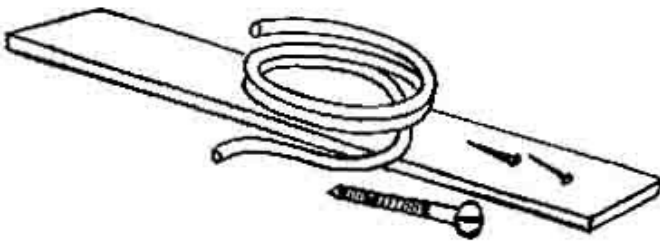

Water Hammer

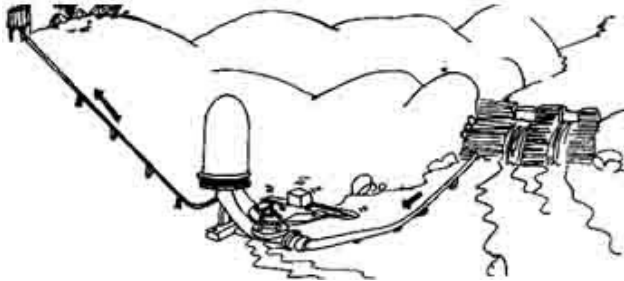

1. This pump, common in hilly areas, uses the water from a running stream and pumps it up. Theoretically it can pump water to almost 40 times the head between the pump and the stream. With this model you can raise water by almost one and a half meters.

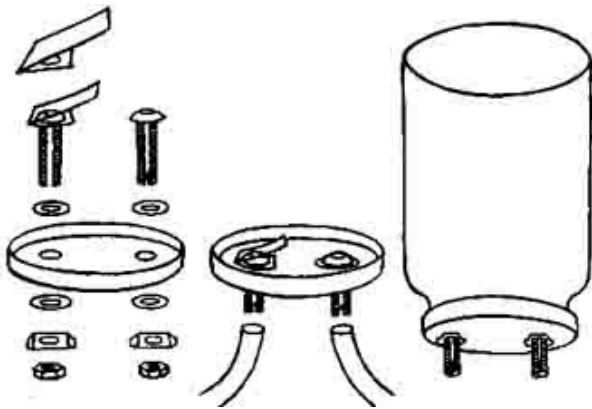

2. Make two holes in a jam jar lid. The holes should be the thickness of the cycle valve tube body. To prevent any leakage, cushion the lid with rubber washers on both sides, put a plastic milk bag strip on the left valve seat. Tighten both the valves to the lid with lock nuts. Attach two plastic hoses to the cycle valve bodies.

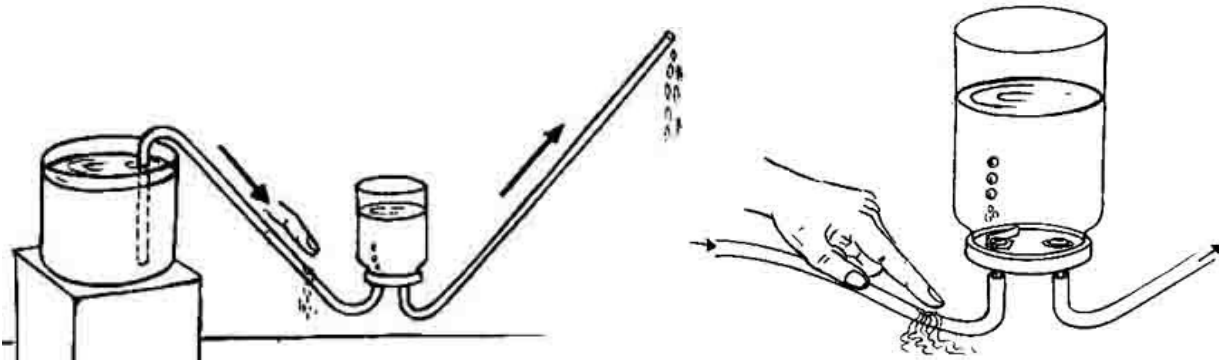

3. Make a small hole in the left-hand pipe near the bottle. Dip this end of the tube in a raised bucket of water. Suck through the hole until water flows through the pipe and comes out of the hole. When water starts flowing steadily then close the hole with a finger. The stream of water will enter the bottle with a jerk. You will have to keep opening and closing the hole - which acts like an impulse valve. With each successive hammer stroke water will rise in the bottle and compress the trapped air. This compressed air, will in turn, push out the water from the other tube and raise it to a greater height.

Diaphragm Pump

As you press the stretched balloon membrane of this pump with your finger, water comes out of the other end.

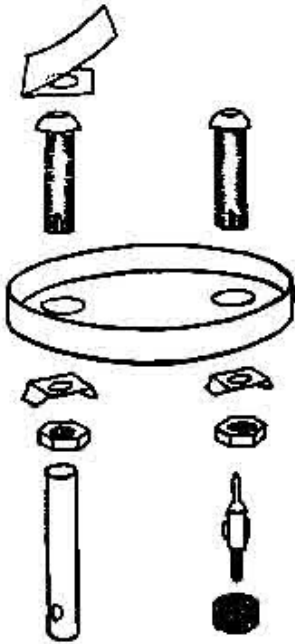

1. Make two 1-cm diameter holes in the lid of a jam jar. Slide a cycle brass valve tube body in each hole and fix them with a lock nut. Before fixing the left valve, wedge a plastic milk bag strip between the valve and the lid. This plastic flap acts like a suction valve. Tightly affix both valves to the lid. Insert the valve stem in the right hand valve and tighten the knurled cap screw on it.

2. The finished assembly of the lid along with the two valves will look like this.

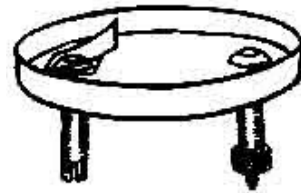

3. Now cover the lid with a torn balloon. Stretch the membrane and tie it tightly around the lid with a string. Tight fit a small plastic pipe - outer body of an old sketch pen to the left-hand valve. Make a hole in this pipe and immerse it in a vessel of water. Hold the rim of the lid with one hand and keep pressing and releasing the membrane with a finger. Soon water will be dripping out form the right hand valve.



